



## **LX27 Clamshell Roof Top Tent Instructions Manual**



## **TABLE OF CONTENTS**

<b>1</b>	<b>GETTING STARTED</b>	<b>3</b>
<b>1.1</b>	<b>Product Contents</b>	<b>3</b>
<b>1.2</b>	<b>What You Need for The Install</b>	<b>4</b>
1.2.1	Tools Required	4
<b>2</b>	<b>INSTALL THE GAS STRUTS TO YOUR TENT</b>	<b>5</b>
<b>3</b>	<b>TENT ELECTRICAL PACKAGE</b>	<b>7</b>
<b>4</b>	<b>MOUNTING YOUR TENT</b>	<b>8</b>
<b>4.1</b>	<b>Positioning Your Tent</b>	<b>8</b>
<b>4.2</b>	<b>Installation Options</b>	<b>9</b>
4.2.1	Option 1 – No foot extrusion rails	10
4.2.2	Option 2 – Flush fitment bracket on the side of the foot extrusion rail	10
4.2.3	Option 3 – Fitment fasteners in internal slot	10
<b>5</b>	<b>CARE &amp; MAINTENANCE</b>	<b>11</b>
<b>5.1</b>	<b>Canvas Care</b>	<b>11</b>
5.1.1	Cleaning Canvas	11
5.1.2	Cleaning Mould	11
<b>5.2</b>	<b>Condensation Management</b>	<b>11</b>
<b>5.3</b>	<b>Mattress Care</b>	<b>12</b>
<b>6</b>	<b>WARRANTY</b>	<b>12</b>

For any further queries, please contact your international dealer.



## 1 Getting Started

Thank you for purchasing your LX27 Clamshell Roof Top tent. The Bush Company have invested significant resources in terms of time and effort to ensure that your LX27 Clamshell Tent reaches the standards of quality, practicality and reliability that The Bush Company is renowned for.

Before getting started with installation of your LX27 Clamshell tent please make sure that the items listed below are present:

### 1.1 Product Contents

- 1 x LX27 Clamshell tent
- 1 x High density foam underlay
- 1 x Mattress with canvas cover
- 1 x Ladder with canvas bag
- 1 x Ladder mounting bracket mounted to rear of tent.
- 1 x Ladder mounting bracket inside ladder bag.
- 2 x Small spring rods
- 2 x K4153 Gas lifting struts, including:
  - 4 x Male ball with thread
  - 4 x Female ball receivers
  - 4 x Locking pins
- 1 x LED rechargeable tri-colour light (Velcro's to side of top shell)
- 1 x Telescopic pole – normally located at the side of mattress.
- 2 x Foot rail fitment extrusions
- 12 x M8 x 25 Hexagonal screws
- 12 x M8 x 24 Body washers
- 12 x M8 Nyloc nuts
- 12 x M8 T-washers
- 4 x Foot rail end bracket set:
  - 2 x Left hand brackets
  - 2 x Right hand brackets
  - 4 x M8 x 16 Socket button head screws
  - 4 x M8 Flat washers
  - 4 x M8 spring washers
  - 4 x M8 Square nuts
- 1 x Flush mount bracket set - inside ladder bag:
  - 6 x flush mount brackets.
  - 12 x M8x20 Hexagonal screws
  - 6 x M8 x 25 Hexagonal screws.
  - 12 x M8 Flat washers.
  - 6 x M8 Body Washers.
  - 18 x M8 Nyloc nuts.
  - 18 x T-washers.

If any of these items are not present, please contact The Bush Company immediately by email and we will send out the missing component. Please provide the serial number of your LX27 Clamshell tent when communicating with The Bush Company, it is stamped to the gusset at the front section of the roof of the tent.

For any further queries, please contact your international dealer.

## 1.2 What You Need for The Install

The Bush Company or one of our stockists can assemble and install your tent, but if you choose to install the rooftop tent yourself, please make sure that you have done the due-diligence on your intended install to ensure that it does not create any safety issues and ensure that you follow standard safety precautions when undertaking the install.

### 1.2.1 Tools Required

The following tools are recommended for the install.

- 13mm & 14mm ratchet spanners
- Ratchet with 13mm socket
- Ratchet extension
- 5mm Allen Key
- Anti-seize grease (e.g.: Lanotec Type A-Grease or Nickel Anti-Seize)
- Ratchet strap – to assist with compressing gas struts for fitment

Please be aware that the tent is a heavy item and cannot be moved by 1 person. When it comes to raising the tent in the air for installation please ensure that you are using a rated lifting device and that all relevant safety procedures are adhered to.

---

For any further queries, please contact your international dealer.

## 2 Install the Gas Struts To Your Tent

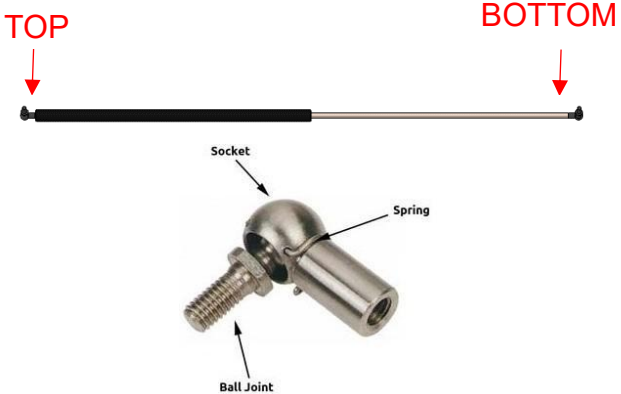
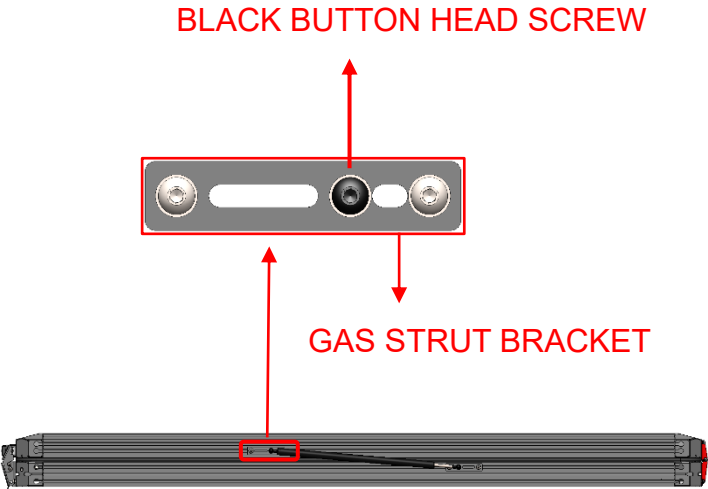
<u><b>INSTRUCTION</b></u>	<u><b>PRESENTATION</b></u>
<p><b>STEP 1:</b></p> <ul style="list-style-type: none"> <li>• OPEN THE TENT AND REMOVE THE GAS STRUTS, LADDER AND SPRING RODS.</li> <li>• CLOSE THE TENT.</li> </ul>	
<p><b>STEP 2:</b></p> <ul style="list-style-type: none"> <li>• IDENTIFY THE TOP OF THE GAS STRUT.</li> <li>• REMOVE THE SPRING FROM THE BALL AND SOCKET END POINTS</li> <li>• REMOVE THE BALL JOINTS FROM BOTH ENDS OF THE GAS STRUTS.</li> </ul>	
<p><b>STEP 3:</b></p> <ul style="list-style-type: none"> <li>• APPLY THE FOLLOWING TO BOTH SIDES OF THE TENT.</li> <li>• REMOVE THE BLACK BUTTON HEAD SCREW FROM THE GAS STRUT BRACKET ON THE TOP SHELL.</li> <li>• REMOVE THE EXISTING WASHER &amp; PLACE IT OVER THE TOP PART OF THE GAS STRUTS' THREAD.</li> <li>• SCREW THE TOP PART OF THE GAS STRUT INTO THE NUT, HELD IN PLACE BY THE BLACK BUTTON HEAD SCREW. ENSURE TO PROPERLY FASTEN THE BALL JOINT.</li> </ul>	

For any further queries, please contact your international dealer.

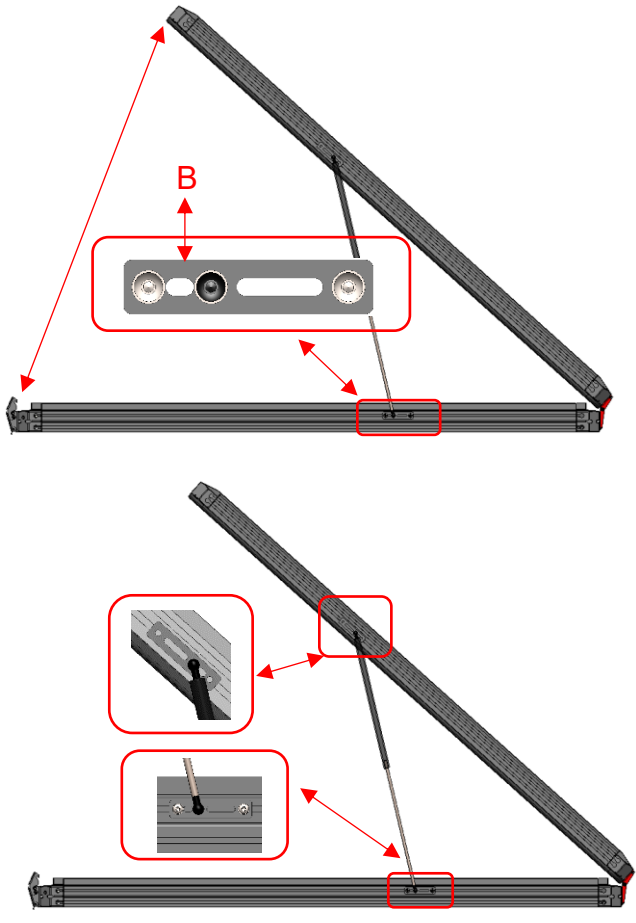
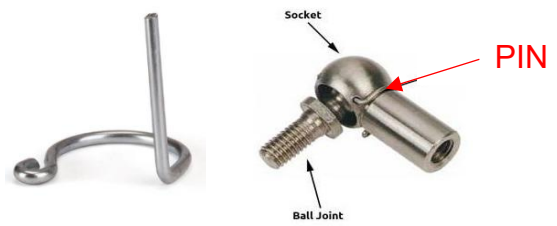
<p style="text-align: center;"><b>STEP 4:</b></p> <ul style="list-style-type: none"> <li>• OPEN THE TOP SHELL UNTIL THE CANVAS HAS REACHED ITS MAXIMUM TENSION.</li> <li>• USE THE PROVIDED TELESCOPIC POLE TO MAINTAIN THE OPEN POSITION.</li> <li>• WITH THE GAS STRUT HANGING FROM THE TOP SHELL, USE A RATCHET STRAP TO COMPRESS THE GAS STRUT. THIS WILL ENABLE YOU TO ALIGN THE THREAD ON THE BOTTOM OF THE STRUT, WITH THE RELEVANT NUT POSITION ON THE BOTTOM SHELL.</li> <li>• REPEAT THE GAS STRUT FASTENING PROCESS FOR THE BOTTOM SHELL.</li> </ul>	
<p style="text-align: center;"><b>STEP 5:</b></p> <ul style="list-style-type: none"> <li>• ENSURE TO SECURE ALL 4 BALL JOINTS ON THE GAS STRUTS VIA THE SPRING LOCKING PIN.</li> </ul>	

For any further queries, please contact your international dealer.

### 3 Tent Electrical Package

Your rooftop tent is supplied with:

- An internal rechargeable Tri-Colour LED light with USB charging cable.
- Electrical outlets on the inside of the tent which includes two sets of 12V CIG and USB outlets connected in the circuit.
- A 20amp resettable fuse is connected to the electrical outlet system, the switch for this is located on the rear of one of the power outlets.
- Anderson plug power connection point located under the front left-hand side of the tent.

**Note:** When running a permanent connection to this point a 20amp in-line fuse must be used and the correct thickness electrical cable must be used to safely handle 25amp over the distance as needed.

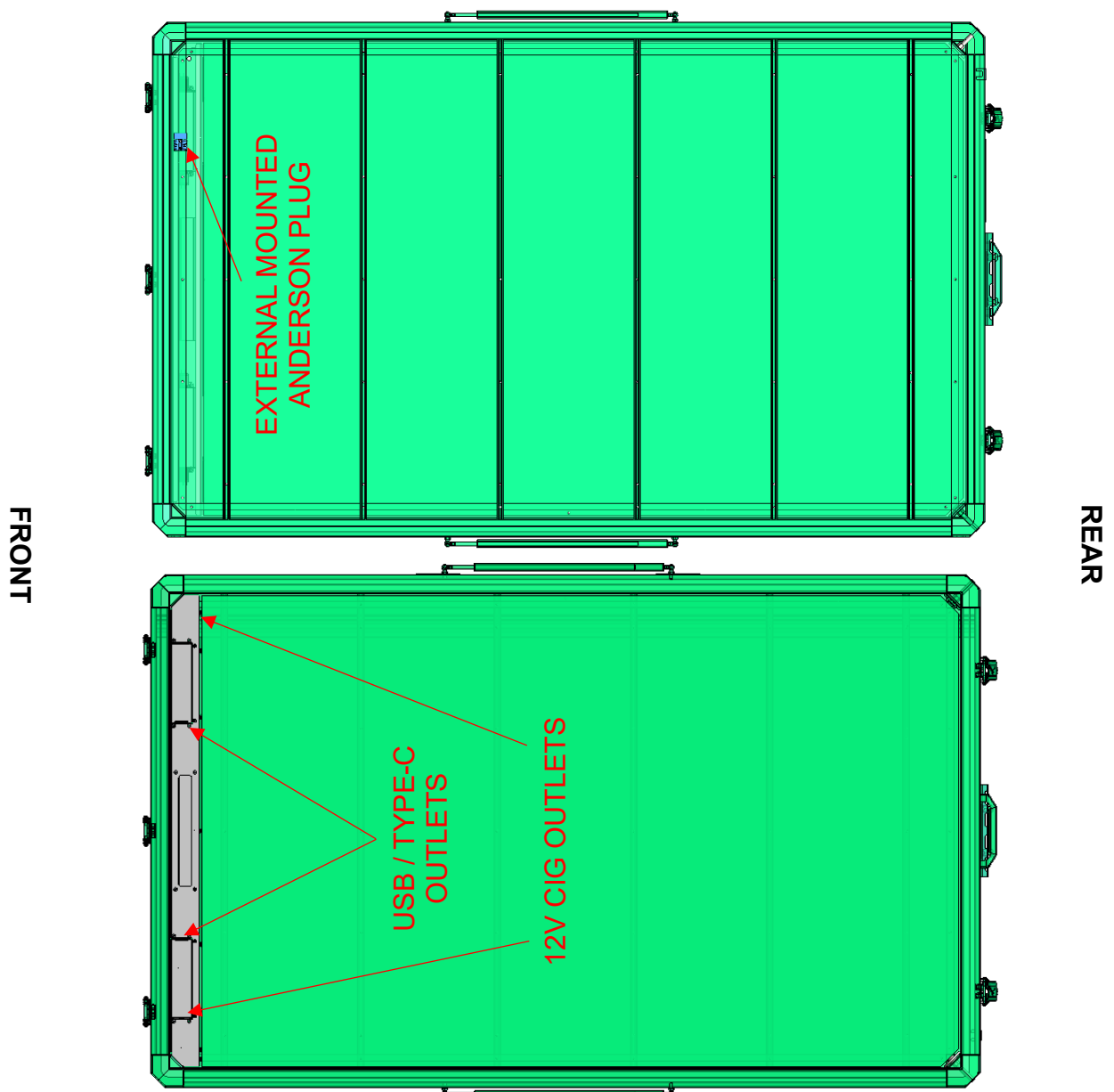

For any further queries, please contact your international dealer.

## 4 Mounting Your Tent

Before installing your tent, you must ensure that your chosen mounting solution (load bar, roof rack etc.) can support the weight of the tent in dynamic load conditions.

The Bush Company do not recommend mounting the tent without full support running horizontally across the full width of the tent. If this is not done it will void the warranty on your tent.

### 4.1 Positioning Your Tent

When deciding on the position of your rooftop tent there are some specifications which must be considered:

- Unsupported Overhang – 700mm at the front and rear of the tent. **IMPORTANT:** exceeding these limits will void the warranty on your tent.
- If only two load bars are used to support your tent (we recommend 3), they can be no more than 1250mm apart centre to centre.
- If the maximum distance between the front and rear support underneath the tent exceeds 1250mm then a third support **MUST** be used, with a minimum distance from the front and rear supports of 700mm.

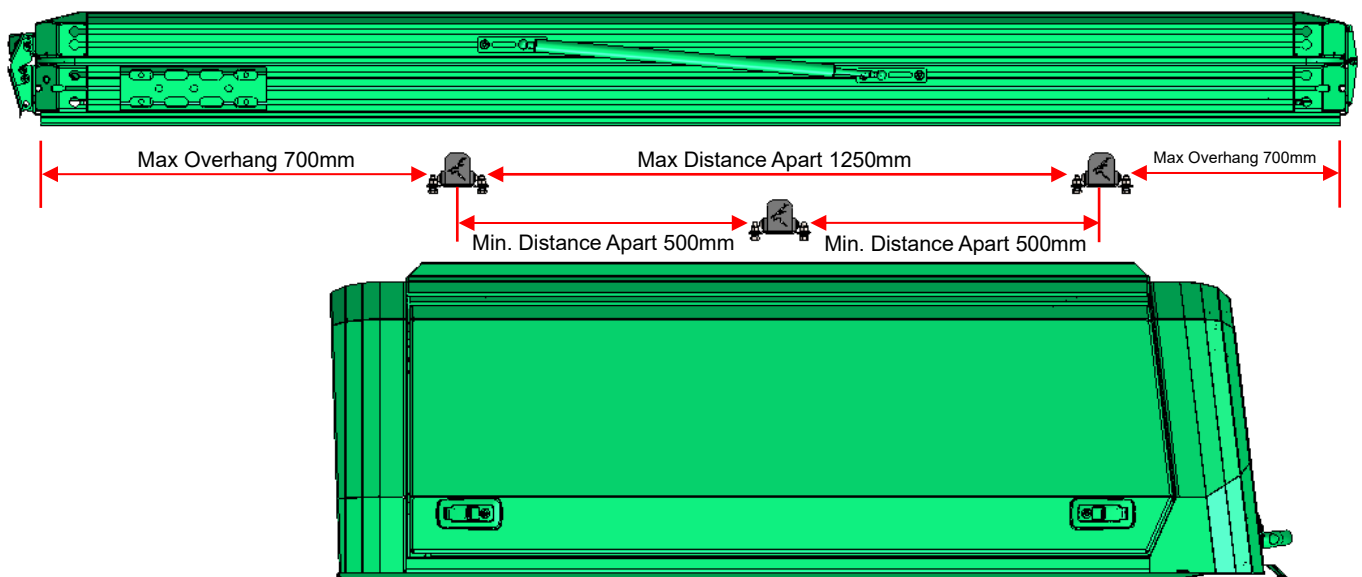

On a ute/pickup, due to the difference in flex between the cab and the tray/canopy, you must not fix the tent across the two, as this will result in damage to the tent and also your vehicle.

For any further queries, please contact your international dealer.



## 4.2 Installation Options

As a standard issue fitment solution, each tent is supplied with two full length foot extrusion rails and 6 x flush mount brackets. The horizontal rails on the underside of the tent provides the option to adjust the foot extrusion rails position according to your desired pitch.

Both foot rails are equipped with pre-drilled holes, which aligns with the horizontal rails on the underside of the tent. Fit the foot extrusion rails to the horizontal rails by installing a M8 x 25mm screw and T-washer into each horizontal rail on both sides of the tent. Align the pre-drilled holes in the foot extrusion rails with the screws, then secure each screw by means of a M8 body washer and M8 Nyloc nut.

The Flush Mount Brackets can then be used to secure your tent to your chosen platform or load bars. Ensure to fit 3 brackets per side of the tent.



### HORIZONTAL RAILS

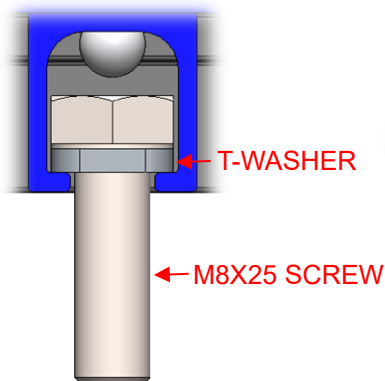

### TENT FOOT EXTRUSION

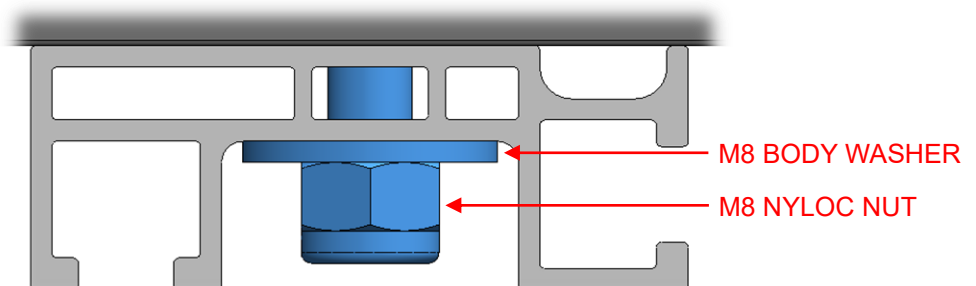

- SLIDE A M8X25 AND T-WASHER INTO EACH SIDE OF EACH HORIZONTAL RAIL.
- PLACE THE FOOT RAILS IN POSITION BY ALIGNING THE PRE-DRILLED HOLES WITH EACH SCREW.
- CONFIRM THAT THE FOOT RAILS ARE IN YOUR DESIRED POSITION.
- SECURE EACH SCREW WITH A M8 BODY WASHER AND M8 NYLOC NUT.
- ONCE THE FOOT RAILS ARE SECURED IN POSITION, PLACE AN END CAP ON EACH OF THE FOOT RAILS ENDS.

**IMPORTANT:** the supplied nuts and bolts are stainless steel, so it is essential to use an anti-seize product on the treads of the bolts (e.g.: Lanotec Type A grease, Nickel Anti-Seize Grease). We also recommend **NOT** to use power tools when tightening the bolts to reduce the risk of seizing an over tightening.

For any further queries, please contact your international dealer.

4.2.1 Option 1 – No foot extrusion rails.

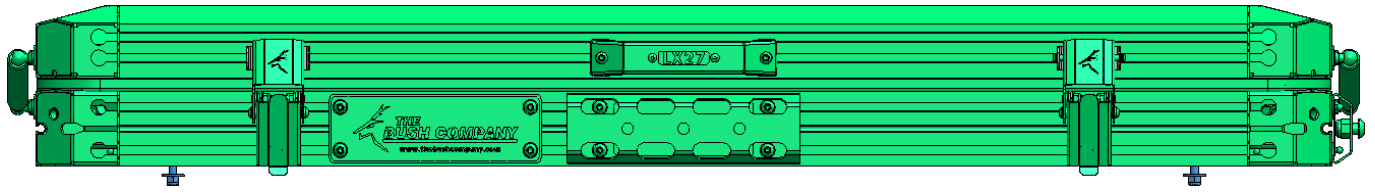

4.2.2 Option 2 – Flush fitment bracket on the side of the foot extrusion rails.

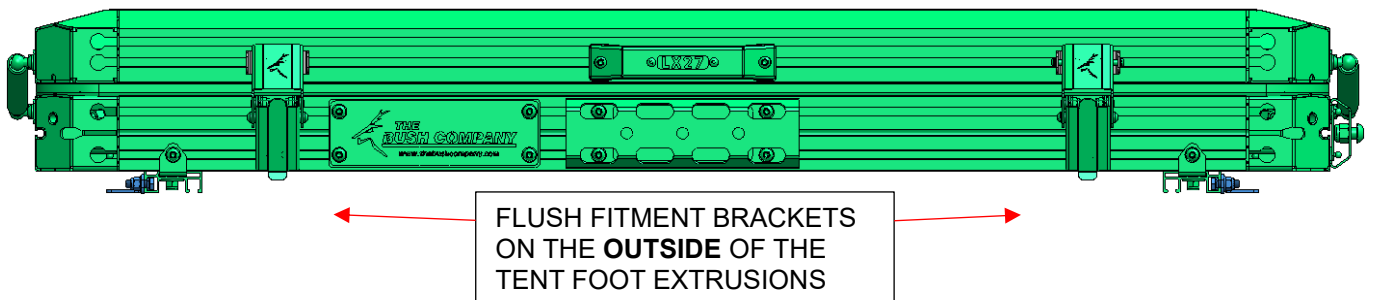

4.2.3 Option 3 – Fitment fasteners in internal slot.

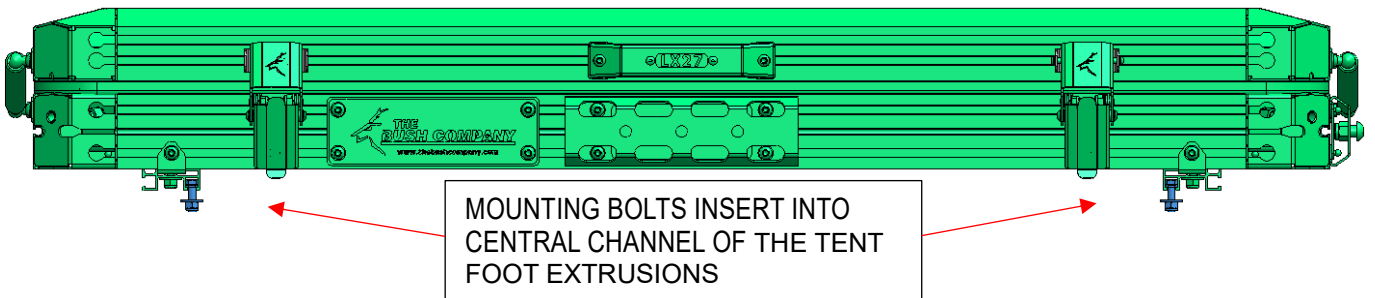

For any further queries, please contact your international dealer.

## 5 Care & Maintenance

Your rooftop tent has been manufactured to the highest standards and with only quality components/materials. There are some basic care and maintenance procedures that we recommend you follow to ensure that your tent provides you with the performance intended for many years to come.

### 5.1 Canvas Care

We recommend that new tents are thoroughly wet down on the outside before first use. This will ensure that your tent performs well in wet weather by allowing the poly/cotton cospun thread and canvas to swell ensuring the take up of any potential leaks in the stitching.

#### 5.1.1 Cleaning Canvas

Should your canvas become excessively dirty or marked please follow these guidelines:

- Do not use soap or detergents on the canvas.
- Do not store the product if wet, allow drying first.
- To clean use a soft brush and cold water.
- Do not expose to petrol, oils or harsh chemicals.

#### 5.1.2 Cleaning Mould

The canvas of your tent has been infused with anti mould and mildew elements during manufacture, but in exceptional circumstances or if the tent is stored incorrectly and you are unfortunate enough to find some mould inside your tent, please follow these guidelines:

- Allow mould to dry
- Remove surface mould off with stiff bristle brush
- Vacuum the area
- Treat area with Oil of Clove spray (diluted spray can be purchased or can be mixed using a few drops of oil into a spray bottle of water)

### 5.2 Condensation Management

Condensation is a natural occurrence in cold weather. In confined areas like swags or tents the body releases more moisture than the canvas can dispose of, especially if there are two or more people in the tent.

To help to reduce condensation build up, we recommend keeping some of the windows open on the tent to enable airflow on cold nights. If your tent has a vent above the rear entrance, then we recommend that this is always kept open.

It is also possible to use moisture absorbing silica gel pouches inside your tent when travelling and when storing your tent. These pouches are widely available, each pouch can absorb approximately 40% of its own weight in moisture, and they can be reused by drying them out in the sun or in an oven.

---

For any further queries, please contact your international dealer.



### 5.3 Mattress Care

Your mattress absorbs moisture through body sweat. When travelling for extended periods it is a good idea to move your bedding back from the mattress during the day to allow the mattress to breathe.

If you are not using your tent for an extended period (more than 10 days) we recommend opening the tent regularly to allow it to air out, and possibly even remove the mattress and store it separately until your next trip.

## 6 Warranty

The Bush Company prides itself on the quality of manufacture of all its products.

In the unlikely event that you experience an issue with your rooftop tent please contact the stockist or Bush Company outlet that you purchased your tent from to initiate the warranty process.

If you are in Australia, please go to The Bush Company Australia website and visit the My Account section to raise a warranty support ticket. Full details of how to do this can be found here <https://www.thebushcompany.com.au/support-warranty/>

The full details of the warranty policy that applies to your tent is available on the product page of The Bush Company website.

---

For any further queries, please contact your international dealer.